

RT-)) 00 `#F H!+) \$\$ PERFORMANCE DATA

AIR TEC

AIR SYSTEMS



Type	Number	RH!)) \$\$#	RH!+) \$\$#
Phase		3	3
Output	50Hz	5.5	7.5
	60Hz	6.3	8.6
Voltage	50Hz	208-255/360-440	208-255/360-440
	60Hz	220-265/380-460	220-265/380-460
Current	50Hz	21/12	27/15.6
	60Hz	26.5/15.3	34/19.6
Vacuum	50Hz	270	300
	60Hz	290	350
Pressure	50Hz	300	400
	60Hz	290	400
Air Flow	50Hz	9.2	9.2
	60Hz	10.9	10.9
Insulation Class		H	H

AIR TEC

AIR SYSTEMS

RT-5500/3 & RT-7500/3 series (Blowing)

50Hz _____

60Hz _____

The technical data is based on 1 bar (abs.) free atmosphere and 20° C with Inlet air density 1.2kg/m³, includes 10% variance.

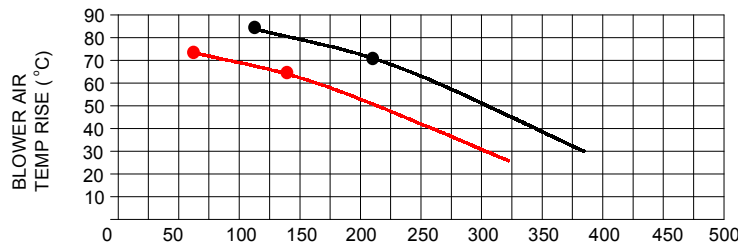
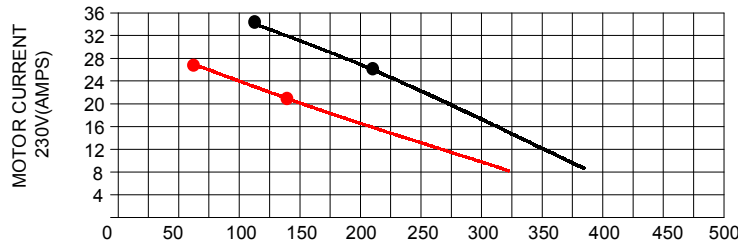
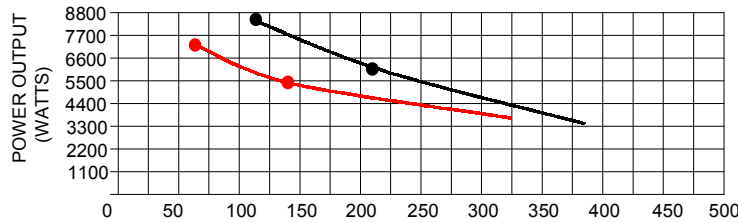
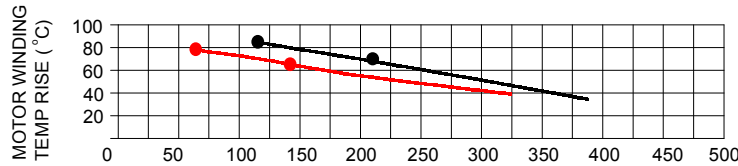
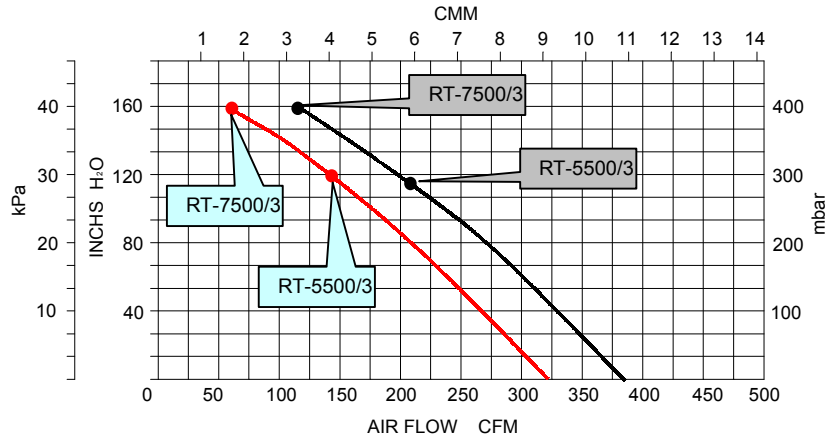

RT-5500/3 & RT-7500/3 series (Suction)

50Hz —————

60Hz —————

The technical data is based on 1 bar (abs.) free atmosphere and 20° Cwith Inlet air density 1.2kg/m³,includes 10%variance.

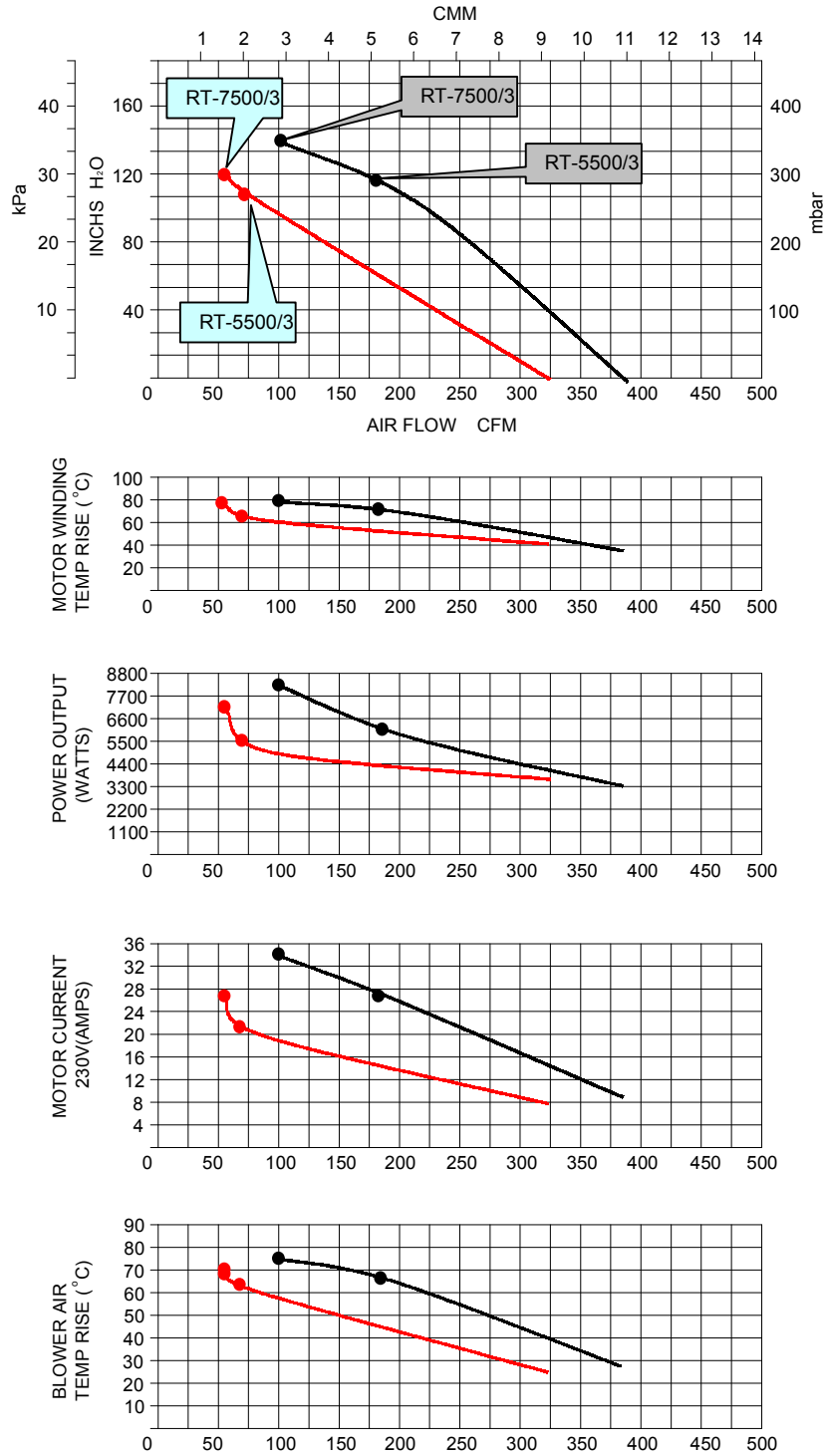

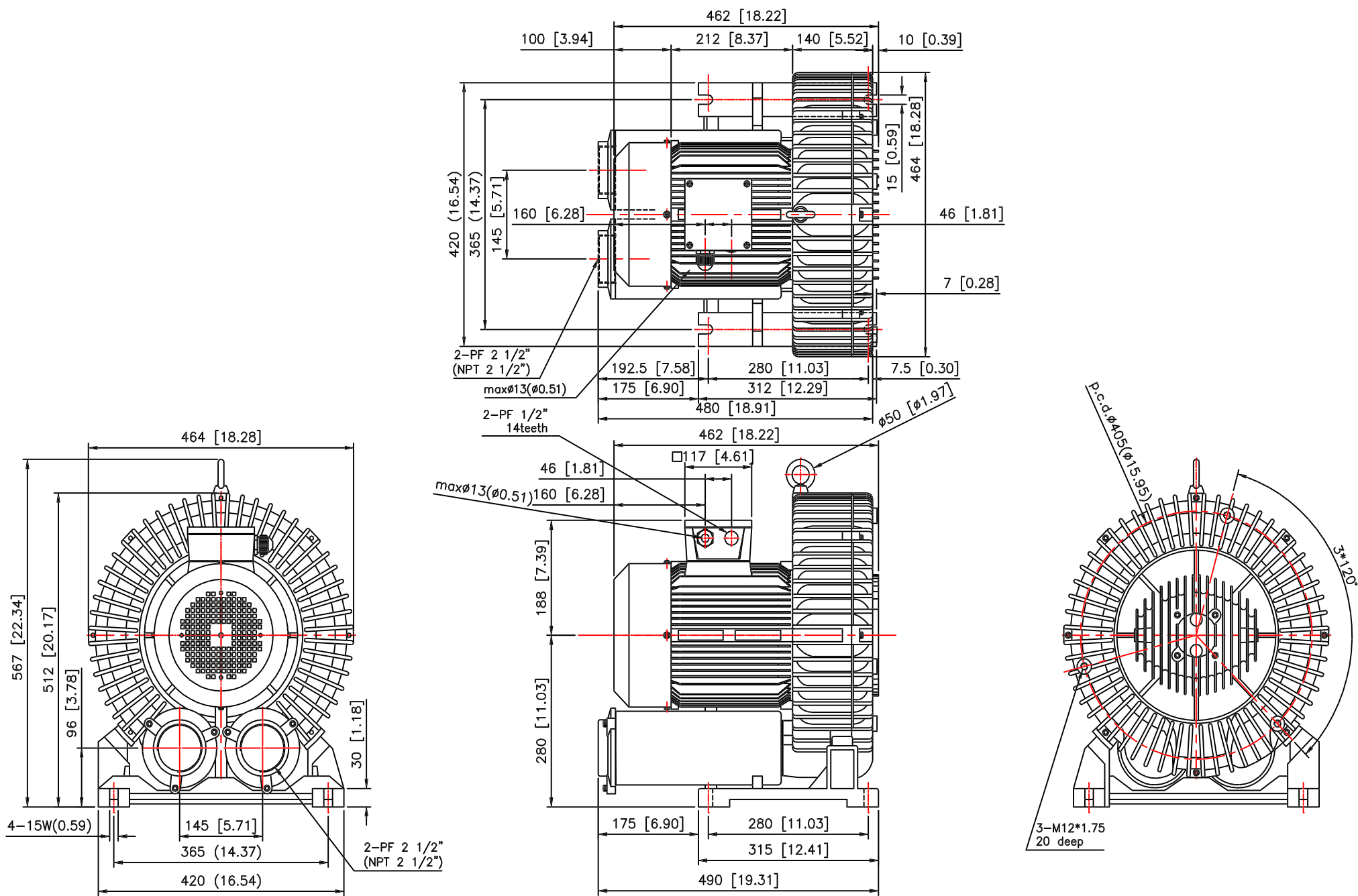

Drawing name : RT-5500 & RT-7500